

Product Information

2-wire Door Station

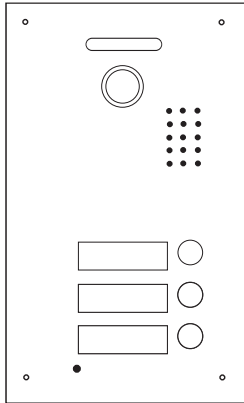

DESCRIPTION

2-wire system stainless steel fisheye wide angle door station

DIMENSION

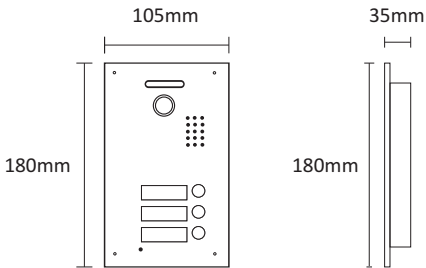

FEATURES

- ▶ 700 TV lines HD camera
- ▶ Stainless steel panel
- ▶ Fisheye wide angle camera
- ▶ Name plate display with LED background
- ▶ Compatible with all 2-wire models

1. Parts and Functions

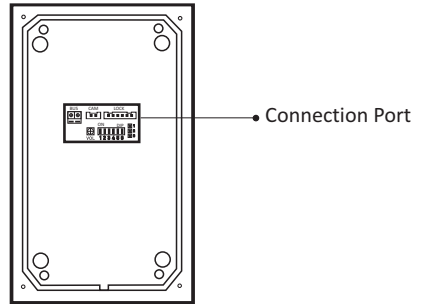
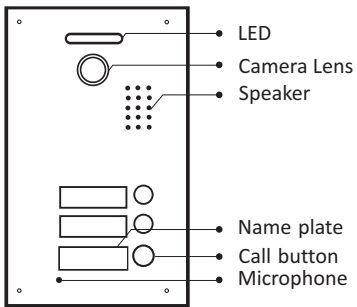

2. Installation

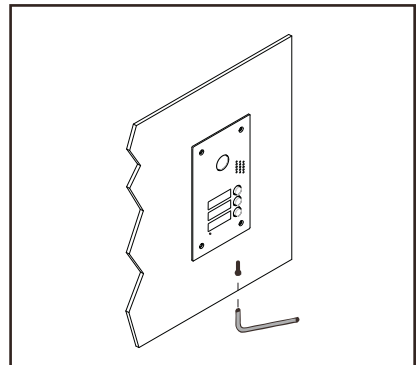
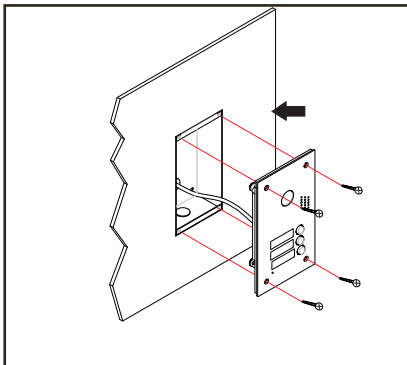
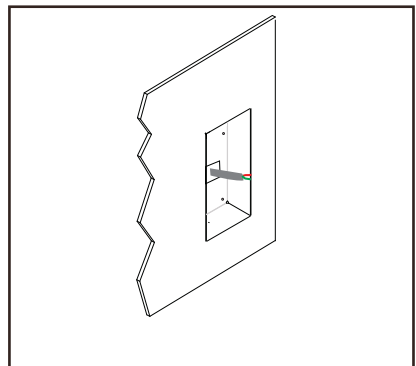
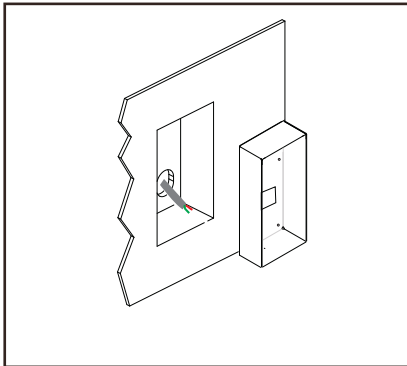

3. Specification

Model No.	PL738-3
Camera Lens	1/3" CMOS
Resolution	700 TV Lines
IR LED	6pcs IR LED for 3 meters illumination
Power Supply	DC15V 1500mA ; AC100—240V
Power Consumption	Standby : <0.5 w; working: <10w
Wiring	2 wires
Installation	Flushing mounted
Talking time	60 sec
Monitoring time	60 sec
Operating Temperature	-10 ~ +60
Dimension	180(H)× 105(W)× 32(D)mm